



**KITZ<sup>®</sup>**

COMMERCIAL PRODUCTS

Condensed Catalog

Quality in every choice, every time.



# INDEX

<b>Ball</b>	
Lead Free Copper Alloy .....	1-3, 5
Bronze & Brass.....	6-8
Speciality .....	9-11
Cast Iron .....	22
Carbon & Stainless.....	12
Accessories.....	11
<b>Butterfly</b> .....	14, 15
<b>Gate</b>	
Lead Free Copper Alloy .....	3
MSS Bronze.....	16, 17
Bronze & Brass.....	20
Cast Iron .....	21, 22
<b>Globe</b>	
Lead Free Copper Alloy .....	4
MSS Bronze.....	18, 19
Bronze & Brass.....	20, 21
Cast Iron .....	22
<b>Check</b>	
Lead Free Copper Alloy .....	4, 5
MSS Bronze.....	19
Bronze & Brass.....	21
Cast Iron .....	23
Y-Strainers .....	23

Valve Code	Page #	Valve Code	Page #	Valve Code	Page #	Valve Code	Page #
01.....	20	36.....	21	62M.....	8	73.....	21
02.....	21	37.....	17	63M.....	8	75.....	22
03.....	20	38.....	21	68.....	6	76.....	22
04.....	19	39.....	12	68AB.....	10	77.....	22
07.....	20	40.....	16	68AD.....	9	78.....	23
09.....	18	42T.....	17	68ALL.....	7	79.....	23
10.....	18	45.....	16	68AMLL.....	7	80.....	23
11.....	18	46.....	17	68C.....	10	90.....	22
15.....	23	49M.....	12	68LL.....	8	91.....	22
16.....	23	50.....	12	68M.....	7	119.....	12
17.....	18	51.....	8	68P.....	8	129.....	12
17S.....	18	52.....	12	68PM.....	8	200 Series.....	12
18.....	18	54(P).....	10	68O.....	9	300 Series.....	12
19.....	19	58.....	6	68S.....	10	800 Series.....	1-5
22.....	19	58W.....	6	68U.....	9	801XL.....	5
22T.....	19	59.....	6	69.....	6	801XLC.....	5
23.....	19	59W.....	6	69ALL.....	7	4244.....	15
24.....	16	60.....	11	69AD.....	9	5000 Series.....	14
25.....	16	60F.....	11	69AMLL.....	7	6000 Series.....	14
26.....	21	60FF.....	11	69C.....	10	7032.....	23
27.....	20	60FO.....	11	69M.....	7		
28.....	20	60SQ.....	11	69U.....	9		
29.....	19	62.....	8	72.....	21		

<b>Sample Spec Sheet.....</b>	<b>24</b>
<b>Standards &amp; 3rd Party Certifications .....</b>	<b>25</b>
<b>Cross Reference Charts .....</b>	<b>26 - 29</b>
<b>Terms &amp; Conditions .....</b>	<b>34</b>

# LEAD FREE\* COPPER ALLOYS



## # 858



600CWP/150WSP (1/4" - 3")  
 400CWP/275@212°F (4")  
 2-pc, Full Port  
 Threaded Ends  
 ASTM A283 C46750  
 ASTM B584 C89530 (4")  
 Plated / Vented Ball  
 PTFE Seats  
 O-Ring Stem Seals  
 MSS SP-110  
 1/4" - 4"

## # 859



600CWP/150WSP  
 2-pc, Full Port  
 Solder Ends  
 ASTM A283 C46750  
 Plated / Vented Ball  
 PTFE Seats  
 O-Ring Stem Seals  
 MSS SP-110  
 3/8" - 3"

## # 858W - Wing Handle



600CWP/150WSP  
 2-pc, Full Port  
 Threaded Ends  
 ASTM A283 C46750  
 Plated / Vented Ball  
 PTFE Seats  
 O-Ring Stem Seals  
 MSS SP-110  
 1/4" - 2"

## # 859W - Wing Handle



600CWP/150WSP  
 2-pc, Full Port  
 Solder Ends  
 ASTM A283 C46750  
 Plated / Vented Ball  
 PTFE Seats  
 O-Ring Stem Seals  
 MSS SP-110  
 3/8" ~ 2"

## # 868



600CWP / 325 @ 212°F  
 2-pc, Full Port  
 Threaded Ends  
 ASTM A283 C46750  
 Plated / Vented Ball  
 PTFE Seats  
 PTFE Packing  
 MSS SP-110  
 1/4" - 2"

## # 869



600CWP / 325 @ 212°F  
 2-pc, Full Port  
 Solder Ends  
 ASTM A283 C46750  
 Plated / Vented Ball  
 PTFE Seats  
 PTFE Packing  
 MSS SP-110  
 3/8" - 2"

## # 868M



600CWP / 325 @ 212°F  
 2-pc, Full Port  
 Threaded Ends  
 ASTM A283 C46750  
 316SS / Vented Ball & Stem  
 PTFE Seats  
 PTFE Packing  
 MSS SP-110  
 1/4" - 2"

## # 869M



600CWP / 325 @ 212°F  
 2-pc, Full Port  
 Solder Ends  
 ASTM A283 C46750  
 316SS / Vented Ball & Stem  
 PTFE Seats  
 PTFE Packing  
 MSS SP-110  
 3/8" - 2"

\*Product complies with NSF/ANSI Standard 61, NSF/ANSI Standard 372 and conforms with lead content requirements for "lead free" plumbing as defined by California, Vermont, Maryland, and Louisiana state laws and the U.S. Safe Drinking Water Act that went into effect January 2014.

# LEAD FREE\* COPPER ALLOYS



## # 868AMLL - (Canada Only)



600CWP / 325 @ 212°F  
 2-pc, Full Port  
 Locking Lever  
 Threaded Ends  
 ASTM A283 C46750  
 316SS / Vented Ball & Stem  
 PTFE Seats  
 O-Ring Stem Seals  
 MSS SP-110  
 ½" - 2"

## # 869AMLL - (Canada Only)



600CWP / 325 @ 212°F  
 2-pc, Full Port  
 Locking Lever  
 Solder Ends  
 ASTM A283 C46750  
 316SS / Vented Ball & Stem  
 PTFE Seats  
 O-Ring Stem Seals  
 MSS SP-110  
 ½" - 2"

## # 862M - 3-Piece



600CWP / 325 @ 212°F  
 3-pc, Full Port  
 Threaded Ends  
 ASTM A283 C46750  
 316SS / Vented Ball & Stem  
 PTFE Seats  
 PTFE Packing  
 MSS SP-110  
 ½" - 2"

## # 863 - 3-Piece



600CWP / 325 @ 212°F  
 3-pc, Full Port  
 Solder Ends  
 ASTM A283 C46750  
 Plated / Vented Ball  
 PTFE Seats  
 PTFE Packing  
 MSS SP-110  
 ½" - 2"

## # 863M - 3-Piece



600CWP / 325 @ 212°F  
 3-pc, Full Port  
 Solder Ends  
 ASTM A283 C46750  
 316SS / Vented Ball & Stem  
 PTFE Seats  
 PTFE Packing  
 MSS SP-110  
 ½" - 2"

## # 868AD - with Drain



600CWP / 325 @ 212°F  
 2-pc, Full Port  
 Drainable  
 Threaded Ends  
 ASTM A283 C46750  
 Plated / Vented Ball  
 PTFE Seats  
 O-Ring Stem Seals  
 MSS SP-110  
 ½" - 1"

## # 869AD - with Drain



600CWP / 325 @ 212°F  
 2-pc, Full Port  
 Drainable  
 Solder Ends  
 ASTM A283 C46750  
 Plated / Vented Ball  
 PTFE Seats  
 O-Ring Stem Seals  
 MSS SP-110  
 ½" - 1"

\*Product complies with NSF/ANSI Standard 61, NSF/ANSI Standard 372 and conforms with lead content requirements for "lead free" plumbing as defined by California, Vermont, Maryland, and Louisiana state laws and the U.S. Safe Drinking Water Act that went into effect January 2014.



**WARNING:** Cancer and Reproductive Harm - [www.P65Warnings.ca.gov](http://www.P65Warnings.ca.gov).

**KITZ®**

LEAD FREE BALL

# LEAD FREE\* COPPER ALLOYS



## # 868C - Cap\* & Chain



600CWP / 325 @ 212°F  
 2-pc, Full Port  
 w/ Cap & Chain  
 NPT x Hose  
 ASTM A283 C46750  
 Plated / Vented Ball  
 PTFE Seats  
 PTFE Packing  
 MSS SP-110  
 1/2" & 3/4"

## # 869C - Cap\* & Chain



600CWP / 325 @ 212°F  
 2-pc, Full Port  
 w/ Cap & Chain  
 Solder x Hose  
 ASTM A283 C46750  
 Plated / Vented Ball  
 PTFE Seats  
 PTFE Packing  
 MSS SP-110  
 1/2" & 3/4"

\* Cap not designed to retain line pressure

## # 854 - 3-Way



400CWP / 275 @ 212°F  
 2-pc. L-Port  
 Threaded Ends  
 ASTM A283 C46750  
 Cr. Plated Ball  
 PTFE Seats  
 O-Ring Stem Seals  
 1/2" - 2"

## # 855 - 3-Way



400CWP / 275 @ 212°F  
 2-pc. L-Port  
 Solder Ends  
 ASTM A283 C46750  
 Cr. Plated Ball  
 PTFE Seats  
 O-Ring Stem Seals  
 1/2" - 2"

## # 807



Class 125  
 200CWP / 125WSP  
 NRS  
 Screwed Bonnet  
 Threaded Ends  
 ASTM A283 C46750  
 Metal to Metal Seat  
 KITZ Std.  
 1/2" - 2"

## # 808



Class 125  
 200CWP / 125WSP  
 NRS  
 Screwed Bonnet  
 Solder Ends  
 ASTM A283 C46750  
 Metal to Metal Seat  
 KITZ Std.  
 1/2" - 2"

## # 827



Class 125  
 200CWP / 180 @ 212°F  
 NRS  
 Over Bonnet 3/8" - 2"  
 Threaded Ends  
 ASTM B584 C89530  
 Metal to Metal Seat  
 KITZ Std.  
 1/2" - 2"

## # 828



Class 125  
 200CWP / 180 @ 212°F  
 NRS  
 Over Bonnet 3/8" - 2"  
 Solder Ends  
 ASTM B584 C89530  
 Metal to Metal Seat  
 KITZ Std.  
 1/2" - 2"

\*Product complies with NSF/ANSI Standard 61, NSF/ANSI Standard 372 and conforms with lead content requirements for "lead free" plumbing as defined by California, Vermont, Maryland, and Louisiana state laws and the U.S. Safe Drinking Water Act that went into effect January 2014.

**LEAD FREE\* COPPER ALLOYS**



**# 811**



Class 125  
200CWP / 180 @ 212°F  
Rising Stem  
Screwed Bonnet  
Threaded Ends  
ASTM B584, C89530  
Metal to Metal Seat  
MSS SP-80, Type 1 design  
½" - 2"

**# 812**



Class 125  
200CWP / 180 @ 212°F  
Rising Stem  
Screwed Bonnet  
Solder Ends  
ASTM B584, C89530  
Metal to Metal Seat  
MSS SP-80, Type 1 design  
½" - 2"

**# 804**



Class 125  
200CWP / 180 @ 212°F  
T-Pattern, Swing Type  
Screwed Cap  
Threaded Ends  
ASTM B584, C89530  
Metal to Metal Seat  
MSS SP-80, Type 3 design  
½" - 2"

**# 814**



Class 125  
200CWP / 180 @ 212°F  
T-Pattern, Swing Type  
Screwed Cap  
Solder Ends  
ASTM B584, C89530  
Metal to Metal Seat  
MSS SP-80, Type 3 design  
½" - 2"

**# 822**



Class 125  
200CWP / 180 @ 212°F  
Y-Pattern. Swing Type  
Screwed Cap  
Threaded Ends  
ASTM B584, C89530  
Metal to Metal Seat  
MSS SP-80, Type 4 design  
½" - 2"

**# 823**



Class 125  
200CWP / 180 @ 212°F  
Y-Pattern. Swing Type  
Screwed Cap  
Solder Ends  
ASTM B584, C89530  
Metal to Metal Seat  
MSS SP-80, Type 4 design  
½" - 2"

**# 822T**



Class 125  
200CWP / 180 @ 212°F  
Y-Pattern. Swing Type  
ASTM B584, C89530  
PTFE Disc  
Screwed Cap  
Threaded Ends  
MSS SP-80, Type 4 design  
½" - 2"

**# 823T**



Class 125  
200CWP / 180 @ 212°F  
Y-Pattern. Swing Type  
ASTM B584, C89530  
PTFE Disc  
Screwed Cap  
Solder Ends  
MSS SP-80, Type 4 design  
½" - 2"

\*Product complies with NSF/ANSI Standard 61, NSF/ANSI Standard 372 and conforms with lead content requirements for "lead free" plumbing as defined by California, Vermont, Maryland, and Louisiana state laws and the U.S. Safe Drinking Water Act that went into effect January 2014.



**WARNING:** Cancer and Reproductive Harm - [www.P65Warnings.ca.gov](http://www.P65Warnings.ca.gov).



## LEAD FREE\* COPPER ALLOYS

### # 836



250CWP / 175 @ 176°F  
 Vertical Lift  
 Spring Loaded  
 FKM Disc  
 Screwed Cap  
 ASTM B584, C89530  
 Threaded Ends  
 KITZ Std.  
 ½" - 2"

### # 826



250CWP / 175 @ 176°F  
 Vertical Lift  
 Spring Loaded  
 FKM Disc  
 Screwed Cap  
 ASTM B584, C89530  
 Solder Ends  
 KITZ Std.  
 ½" - 2"



\*Product complies with NSF/ANSI Standard 61, NSF/ANSI Standard 372 and conforms with lead content requirements for "lead free" plumbing as defined by California, Vermont, Maryland, and Louisiana state laws and the U.S. Safe Drinking Water Act that went into effect January 2014.

## K-PRESS

### 801XL Lead Free‡

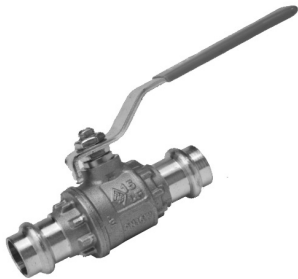

200 CWP  
 2-pc, Full Port  
 UL-NSF 61-G  
 CW 511L  
 Plated Ball  
 PTFE Seats  
 PTFE Packing  
 ½" - 2"

### 801XLC Lead Free‡



200 CWP  
 2-pc, Full Port  
 UL-NSF 61-G  
 CW 511L  
 Plated Ball  
 PTFE Seats  
 O-Ring Stem Seals  
 2 ½" - 4"



‡ Lead Free valves are UL certified to NSF / ANSI Standard 61 -2008 Annex G. As defined by state laws, California AB 1953 and Vermont 193 ACT, these valves are Lead Free, allowing wetted parts to contain no more than 0.25% Lead by weight.

LEAD FREE CHECK & K-PRESS

# BALL - 2-PIECE

BALL FULL PORT

## # 58†



600WOG / 150WSP  
2-pc, Full Port  
CSA, UL, FM ( $\leq 2$ )  
Threaded Ends  
ASTM B283, C37700  
Cr. Plated / Vented Ball  
PTFE Seats  
O-Ring Stem Seals  
MSS SP-110  
 $\frac{1}{4}$ " - 4"

†  $2\frac{1}{2}$ " - 4" - 400 WOG / 150 WSP



## # 59†



600WOG / 150WSP  
2-pc, Full Port  
UL, FM ( $\leq 2$ )  
Solder Ends  
ASTM B283, C37700  
Cr. Plated / Vented Ball  
PTFE Seats  
O-Ring Stem Seals  
MSS SP-110  
 $\frac{3}{8}$ " - 3"



## # 58W - Wing Handle



600WOG / 150WSP  
2-pc, Full Port  
CSA, UL, FM  
Threaded Ends  
ASTM B283, C37700  
Cr. Plated / Vented Ball  
PTFE Seats  
O-Ring Stem Seals  
MSS SP-110  
 $\frac{1}{4}$ " - 2"



## # 59W - Wing Handle



600WOG / 150WSP  
2-pc, Full Port  
UL, FM  
Solder Ends  
ASTM B283, C37700  
Cr. Plated / Vented Ball  
PTFE Seats  
O-Ring Stem Seals  
MSS SP-110  
 $\frac{3}{8}$ " - 2"



## # 68



600WOG / 150WSP  
2-pc, Full Port  
CSA, UL/FM  
Threaded Ends  
ASTM B283, C37700  
Cr. Plated / Vented Ball  
PTFE Seats  
PTFE Packing  
MSS SP-110  
 $\frac{1}{4}$ " - 2"



## # 69



600WOG / 150WSP  
2-pc, Full Port  
UL/FM ( $\frac{3}{8}$ " - 2")  
Solder Ends  
ASTM B283, C37700  
Cr. Plated / Vented Ball  
PTFE Seats  
PTFE Packing  
MSS SP-110  
 $\frac{3}{8}$ " - 3"





# BALL - 2-PIECE

## # 68M - SS Trim



600WOG / 150WSP  
 2-pc, Full Port  
 CSA, UL  
 Threaded Ends  
 ASTM B283, C37700  
 316SS / Vented Ball & Stem  
 PTFE Seats  
 PTFE Packing  
 MSS SP-110  
 1/4" - 2"



## # 69M - SS Trim



600WOG / 150WSP  
 2-pc, Full Port  
 UL  
 Solder Ends  
 ASTM B283, C37700  
 316SS / Vented Ball & Stem  
 PTFE Seats  
 PTFE Packing  
 MSS SP-110  
 3/8" - 2"



## # 68ALL - (Canada Only)



600WOG / 150WSP  
 2-pc, Full Port  
 CSA  
 Locking Lever  
 Threaded Ends  
 ASTM B283, C37700  
 Cr. Plated / Vented Ball  
 PTFE Seats  
 O-Ring Stem Seals  
 MSS SP-110  
 1/2" - 2"



## # 69ALL - (Canada Only)



600WOG / 150WSP  
 2-pc, Full Port  
 UL  
 Locking Lever  
 Solder Ends  
 ASTM B283, C37700  
 Cr. Plated / Vented Ball  
 PTFE Seats  
 O-Ring Stem Seals  
 MSS SP-110  
 1/2" - 2"



## # 68AMLL - (Canada Only)



600WOG / 150WSP  
 2-pc, Full Port  
 CSA  
 Locking Lever  
 Threaded Ends  
 ASTM B283, C37700  
 316SS / Vented Ball & Stem  
 PTFE Seats  
 O-Ring Stem Seals  
 MSS SP-110  
 1/2" - 2"



## # 69AMLL - (Canada Only)



600WOG / 150WSP  
 2-pc, Full Port  
 UL  
 Locking Lever  
 Solder Ends  
 ASTM B283, C37700  
 316SS / Vented Ball & Stem  
 PTFE Seats  
 O-Ring Stem Seals  
 MSS SP-110  
 1/2" - 2"



BALL FULL PORT

## BALL - 1, 2 & 3-PIECE

### # 68P\*\* - Mounting Pad



600WOG / 150WSP  
2-pc, Full Port  
UL (1/4" - 2")  
Mounting Pad  
Threaded Ends  
ASTM B283, C37700  
Cr. Plated / Vented Ball  
PTFE Seats  
PTFE Packing  
MSS SP-110  
1/4" - 4"

\*\* 2 1/2" - 4" 400 WOG / 150WSP



### # 68PM\*\* - Mounting Pad



600WOG / 250WSP  
2-pc, Full Port  
UL (1/4" - 2")  
Mounting Pad  
Threaded Ends  
ASTM B283, C37700  
316SS / Vented Ball & Stem  
Locking Lever (1/4" - 2")  
RPTFE Seats  
PTFE Packing  
MSS SP-110  
1/4" - 4"

\*\* 2 1/2" - 4" 400 WOG / 150WSP



### # 68LL - Locking Lever



600WOG / 150WSP  
2-pc, Full Port  
CSA, UL  
Threaded Ends  
ASTM B283, C37700  
Cr. Plated / Vented Ball  
PTFE Seats  
PTFE Packing  
MSS SP-110  
1/4" - 2"



### # 51 - Uni-Body



600WOG / 150WSP  
Unibody  
Reduced Port  
Threaded Ends  
ASTM B283, C37700  
Cr. Plated Ball  
Vented Ball  
1/4" - 2"

### # 62 - 3-Piece



600WOG / 150WSP  
3-pc, Full Port  
Threaded Ends  
ASTM B283, C37700  
Cr. Plated / Vented Ball  
PTFE Seats  
PTFE Packing  
MSS SP-110  
1/4" - 2"

### # 62M - 3-Piece, SS Trim



600WOG / 150WSP  
3-pc, Full Port  
Threaded Ends  
ASTM B283, C37700  
316SS / Vented Ball & Stem  
PTFE Seats  
PTFE Packing  
MSS SP-110  
1/2" - 2"

### # 63M - 3-Piece, SS Trim



600WOG / 150WSP  
3-pc, Full Port  
Solder Ends  
ASTM B283, C37700  
316SS / Vented Ball & Stem  
PTFE Seats  
PTFE Packing  
MSS SP-110  
1/2" - 2"

## BALL - SPECIALITY

### # 68U - Single Union



600WOG/ 150 @ 300°F  
 2-pc, Full Port  
 Single Union  
 Threaded Ends  
 ASTM B283, C37700  
 Cr. Plated / Vented Ball  
 PTFE Seats  
 PTFE Packing  
 MSS SP-110  
 1/4" - 2"

### # 69U - Single Union



600WOG/ 150 @ 300°F  
 2-pc, Full Port  
 Single Union  
 Solder Ends  
 ASTM B283, C37700  
 Cr. Plated / Vented Ball  
 PTFE Seats  
 PTFE Packing  
 MSS SP-110  
 3/8" - 2"

### # 68AD - with Drain



600WOG, 375 @ 200°F  
 2-pc, Full Port  
 Drainable  
 Threaded Ends  
 ASTM B283, C37700  
 Cr. Plated / Vented Ball  
 PTFE Seats  
 O-Ring Stem Seals  
 MSS SP-110  
 1/2" - 1"

### # 69AD - with Drain



600WOG, 375 @ 200°F  
 2-pc, Full Port  
 Drainable  
 Solder Ends  
 ASTM B283, C37700  
 Cr. Plated / Vented Ball  
 PTFE Seats  
 O-Ring Stem Seals  
 MSS SP-110  
 1/2" - 1"

### # 68O MIPS x FIPS



600WOG / 150WSP  
 2-pc, Full Port  
 MIPS x FIPS  
 Threaded Ends  
 ASTM B283, C37700  
 Cr. Plated / Vented Ball  
 PTFE Seats  
 PTFE Packing  
 MSS SP-110  
 1/4" - 1"

## BALL - SPECIALITY & 3-WAY

### # 68S - Safety Exhaust



200 WOG  
2-pc, Full Port  
Safety Exhaust  
Threaded Ends  
ASTM B283, C37700  
Cr. Plated Ball  
PTFE Seats  
PTFE Packing  
Locking Lever  
MSS SP-110  
1/4" - 2"

### # 68AB - Barbed End



600WOG  
2-pc, Full Port  
Barbed x FIPS  
ASTM B283, C37700  
Cr. Plated / Vented Ball  
PTFE Seats  
O-Ring Stem Seals  
MSS SP-110  
1/2" - 1"

### # 68C - Cap\* & Chain



600WOG / 150WSP  
2-pc, Full Port  
NPT x Hose  
Cap & Chain  
ASTM B283, C37700  
Cr. Plated / Vented Ball  
PTFE Seats  
PTFE Packing  
MSS SP-110  
1/2" & 3/4"

### # 69C - Cap\* & Chain



600WOG / 150WSP  
2-pc, Full Port  
Solder x Hose  
Cap & Chain  
ASTM B283, C37700  
Cr. Plated / Vented Ball  
PTFE Seats  
PTFE Packing  
MSS SP-110  
1/2" & 3/4"

\* Cap is not intended to retain pressure

### # 54P\* - 3-Way



400WOG / 150 @ 300°F  
2-pc. L-Port  
Mounting Pad\*  
Threaded Ends  
ASTM B283, C37700  
Cr. Plated Ball  
PTFE Seats  
O-Ring Stem Seals  
1/2" - 2"

\* Mounting Pad N/A on 1/4", 3/8", 2-1/2", 3", Order as Code No. 54

## BALL - GAS APPLIANCE & ACCESSORIES

### # 60

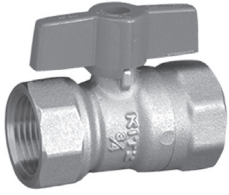

125 WOG  
**CSA**  
 ASTM B283, C37700  
 Cr. Plated Ball  
 FIPS  
 $\frac{3}{8}$ " - 1"



### # 60SQ



125 WOG  
**CSA**  
 ASTM B283, C37700  
 Cr. Plated Ball  
 FIPS  
 $\frac{3}{8}$ " - 1"



### # 60F



125 WOG  
**CSA**  
 ASTM B283, C37700  
 Cr. Plated Ball  
 FIPS x Flare  
 $\frac{1}{2}$  x  $\frac{3}{8}$ ,  $\frac{1}{2}$  x  $\frac{1}{2}$ ,  $\frac{3}{4}$  x  $\frac{5}{8}$



### # 60FF

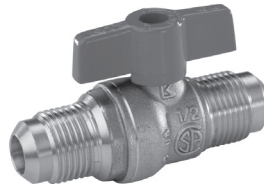

125 WOG  
**CSA**  
 ASTM B283, C37700  
 Cr. Plated Ball  
 Flare x Flare  
 $\frac{3}{8}$ ",  $\frac{1}{2}$ ",  $\frac{1}{4}$ "



### # 60FO



125 WOG  
**CSA**  
 ASTM B283, C37700  
 Cr. Plated Ball  
 MIPS x Flare  
 $\frac{1}{2}$  x  $\frac{1}{2}$



## ACCESSORIES\*

### 62/63, 68/69 Series

Memory Stop  
 SS Locking Lever  
 Oval Handle/Locking Oval Handle  
 Insulated Stem Extension (ISE) w/ Memory Stop  
 Insulated Stem Extension (ISEP) UL2043  
 Wing Handle  
 Anti-Static Grounding Spring



Insulated Stem Extension (68-100-ISE-3)

### 58/59 Series

Memory Stop  
 SS Lever & Nut  
 Oval Handle  
 Stem Extension (EL)  $\frac{1}{4}$ " - 4"  
 Insulated Stem Extension (ISEP) UL2043  
 Wing Handle  
 Anti-Static Grounding Spring



Insulated Stem Extension (68-012-ISEP)  
 ISEP also available on the K-Press Model No. 801



Stem Extension (58-100-EL-602)

# CARBON & STAINLESS STEEL

BALL  
CARBON  
&  
STAINLESS

# 50 - One-Piece



600WOG / 150WSP  
Reduced Port  
Threaded Ends  
ASTM A216, Gr WCB  
316 SS Ball & Stem  
Vented Ball  
¼" - 2"

#52 - One-Piece



600WOG / 150WSP  
Reduced Port  
Threaded Ends  
ASTM A351, Gr. CF8M  
316 SS Ball & Stem  
Vented Ball  
¼" - 2"

# 119\*\* - One-Piece



2000WOG\* / 150WSP  
Regular Port  
Threaded Ends  
Locking Oval Handle ¼"-1"  
ASTM A216, Gr. WCB  
316SS / Vented Ball & Stem  
RPTFE Seats  
Graphite\*\* Packing  
MSS SP-110  
¼" - 2"

# 129\*\* - One-Piece



2000WOG\* / 150WSP  
Regular Port  
Threaded Ends  
Locking Oval Handle ¼"-1"  
ASTM A351, Gr. CF8M  
316SS / Vented Ball & Stem  
RPTFE Seats  
Graphite\*\* Packing  
MSS SP-110  
¼" - 2"

# 49M, 217, 219\*\*, 237, 239\*\* - Two-Piece†



2000WOG\* / 150WSP  
Regular Port  
Threaded Ends  
Locking Oval Handle ¼"-1"  
ASTM A216, Gr. WCB  
316SS / Vented Ball & Stem  
RPTFE Seats  
PTFE/Graphite\*\* Packing  
MSS SP-110  
¼" - 2"

# 39, 227, 229\*\*, 247, 249\*\* - Two-Piece†



2000WOG\* / 150WSP  
Regular Port  
Threaded Ends  
Locking Oval Handle ¼"-1"  
ASTM A216, Gr. WCB  
316SS / Vented Ball & Stem  
RPTFE Seats  
PTFE/Graphite\*\* Packing  
MSS SP-110  
¼" - 2"

# 317, 317F, 319\*\*, 319F\*\* - Three-Piece



1500WOG‡ / 240WSP‡  
Regular Port / Full Port  
Threaded, SW, BW Ends  
Locking Oval Handle ¼"-1"  
ASTM A216, Gr. WCB  
316SS / Vented Ball & Stem  
RPTFE Seats  
PTFE/Graphite\*\* Packing  
PTFE/Graphite\*\* Gasket  
MSS SP-110  
¼" - 2½"

# 327, 327F, 329\*\*, 329F\*\* - Three-Piece



1500WOG‡ / 240WSP‡  
Regular Port / Full Port  
Threaded, SW, BW Ends  
Locking Oval Handle ¼"-1"  
ASTM A351, Gr. CF8M  
316SS / Vented Ball & Stem  
RPTFE Seats  
PTFE/Graphite\*\* Packing  
PTFE/Graphite\*\* Gasket  
MSS SP-110  
¼" - 2½"

\* 1¼" - 2" 1500 WOG max.

‡ 2" FullPort, 2½" Regular Port 1000WOG/186WSP

\*\* Graphite Packing and Gasket is standard in API 607 Fire Tested valves.

† 237, 239, 247, 249 - Seal Welded Body/Cap.



# BUTTERFLY

LEAD FREE\*



## LUG Style - Bi Directional Dead End Service



Full Rated Bi-Directional Dead End Service

Design	MSS SP-67, API 609 Category A
2" - 12"	250 WOG Molded in Seat Lever ≤8", Gear 10"≤
14" - 24"	150 WOG Booted Seat Gear Operated
Body	Ductile Iron - ASTM A536
Disc	Aluminum Bronze Ductile Iron - ENP 316 SS
Stem	Stainless Steel
Seat	EPDM Buna
Mounting Pad	ISO 5211

KITZ Lug Style Butterfly valves are rated for bi-directional dead end service to the full working pressure of the valve with the downstream flange removed. In dead end service exceeding 96 hours, a downstream flange is recommended.

## WAFER Style



Ductile Iron Body ASTM A536

Design	MSS SP-67, API 609 Category A
2" - 12"	250 WOG Molded in Seat Lever ≤8", Gear 10"≤
14" - 24"	150 WOG Booted Seat Gear Operated
Body	Ductile Iron - ASTM A536
Disc	Aluminum Bronze Ductile Iron - ENP 316 SS
Stem	Stainless Steel
Seat	EPDM Buna
Mounting Pad	ISO 5211



\*Butterfly valves with AlBrz or SS disc conform with lead content requirements for "lead free" plumbing as defined by California, Vermont, Maryland, and Louisiana state laws and the U.S. Safe Drinking Water Act. These products further conform with the requirements of NSF/ANSI Standard 372.

## Memory Stop



**WARNING:** Cancer and Reproductive Harm - [www.P65Warnings.ca.gov](http://www.P65Warnings.ca.gov).





## GROOVED END



Design MSS SP-67  
2" - 12" 300 WOG  
Lever 6"≥, Gear 8"≤  
Body Ductile Iron - Nylon Coated  
Disc Ductile Iron - EPDM Coated ‡  
Stem 410 SS 2 - 2½, 420 SS 3"≤

Mounting Pad ISO 5211

‡ EPDM is Chlorine & Chloramine resistant

100% Holiday tested.



Grooved End Butterfly valves comply with NSF/ANSI Standards 61 and 372. This also conforms with lead content requirements for "lead free" plumbing as defined by California, Vermont, Maryland, and Louisiana state laws and the U.S. Safe Drinking Water Act that went into effect January 2014.

GROOVED END BUTTERFLY

# BRONZE GATE

## # 24



Class 125  
200WOG / 125WSP  
ISRS  
Screwed Bonnet  
ASTM B62  
Threaded Ends  
MSS SP-80, Type 2  
1/2" - 3"

## # 25



Class 150  
300WOG / 150WSP  
ISRS  
Screwed Bonnet  
ASTM B62  
Threaded Ends  
MSS SP-80, Type 2  
1/2" - 3"

## # 45



Class 150  
300WOG / 150WSP  
ISRS  
Screwed Bonnet  
ASTM B62  
Solder Ends  
MSS SP-80, Type 2  
1/2" - 2"

## # 40



Class 125  
200WOG / 125WSP  
NRS  
Screwed Bonnet  
ASTM B62  
Threaded Ends  
MSS SP-80, Type 1A  
3/8" - 2"

## BRONZE GATE

### # 42T



Class 150  
300WOG / 150WSP  
ISRS  
Union Bonnet  
ASTM B62  
Threaded Ends  
MSS SP-80, Type 2  
1/4" - 2"

### # 46



Class 150  
300WOG / 150WSP  
NRS  
Screwed Bonnet  
ASTM B62  
Threaded Ends  
MSS SP-80, Type 1A  
3/8" - 2"

### # 37



Class 300  
1000WOG / 300WSP  
ISRS  
Union Bonnet  
ASTM B61  
Threaded Ends  
MSS SP-80, Type 2  
3/8" - 2"

# BRONZE GLOBE

# 11



Class 125  
200WOG / 125WSP  
Metal to Metal Seat  
Screwed Bonnet  
ASTM B62  
Threaded Ends  
MSS SP-80, Type 1  
1/2" - 3"

# 09

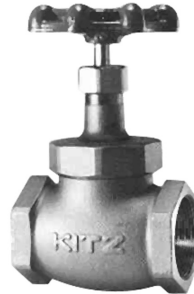

Class 150  
300WOG / 150WSP  
G/F PTFE Disc  
Integral Seat  
Union Bonnet  
ASTM B62  
Threaded Ends  
MSS SP-80, Type 2  
1/4" - 3"

# 10



Class 150  
300WOG / 150WSP  
G/F PTFE Disc  
Integral Seat  
Union Bonnet  
ASTM B62  
Solder Ends  
MSS SP-80, Type 2  
1/4" - 3"

# 17

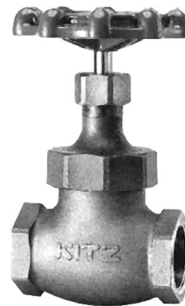

Class 300  
600WOG / 300WSP  
Metal to Metal Seat  
Integral Seat  
Union Bonnet  
ASTM B61  
Threaded Ends  
MSS SP-80, Type 1  
1/4" - 2"

# 17S



Class 300  
600WOG / 300WSP  
Disc & Seat 403SS  
Union Bonnet  
ASTM B61  
Threaded Ends  
MSS SP-80, Type 3  
1/2" - 2"

# 18

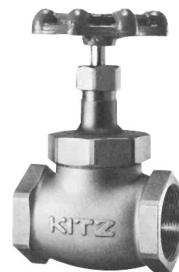

Class 300  
600WOG / 300WSP  
G/F PTFE Disc  
Integral Seat  
Union Bonnet  
ASTM B61  
Threaded Ends  
MSS SP-80, Type 2  
1/4" - 2"

MSS BRONZE GLOBE

# BRONZE CHECK

# 04



Class 125  
200WOG / 125WSP  
T-Pattern  
Metal to Metal Seat  
Screwed Cap  
ASTM B62  
Threaded Ends  
MSS SP-80, Type 3  
3/8" - 4"

# 22



Class 125  
200WOG / 125WSP  
Y-Pattern  
Metal to Metal Seat  
Screwed Cap  
ASTM B62  
Threaded Ends  
MSS SP-80, Type 3  
1/2" - 3"

# 23



Class 125  
200WOG / 125WSP  
Y-Pattern  
Metal to Metal Seat  
Screwed Cap  
ASTM B62  
Solder Ends  
MSS SP-80, Type 3  
1/2" - 3"

# 22T



Class 125  
200WOG / 125WSP  
Y-Pattern  
PTFE Disc  
Screwed Cap  
ASTM B62  
Threaded Ends  
MSS SP-80, Type 4  
1/2" - 2"

# 29



Class 150  
300WOG / 150WSP  
Y-Pattern  
Metal to Metal Seat  
Screwed Cap  
ASTM B62  
Threaded Ends  
MSS SP-80, Type 3  
3/8" - 3"

# 19



Class 300  
600WOG / 300WSP  
Y-Pattern  
Metal to Metal Seat  
Screwed Cap  
ASTM B61  
Threaded Ends  
MSS SP-80, Type 3  
1/2" - 2"

## BRONZE or BRASS GATE & GLOBE

BRONZE OR BRASS GATE & GLOBE

# 07



Class 125  
200WOG / 125WSP  
NRS  
Screwed Bonnet  
ASTM B283, C37700 3/8" - 2"  
ASTM B584, C84400 2 1/2", 3"  
Threaded Ends  
KITZ Std.  
3/8" - 3"

# 27



Class 125  
200WOG / 125WSP  
NRS  
Over Bonnet 3/8" - 2"  
Screwed Bonnet 2 1/2" - 4"  
ASTM B62  
Threaded Ends  
KITZ Std.  
3/8" - 4"

# 28



Class 125  
200WOG / 125WSP  
NRS  
Over Bonnet 3/8" - 2"  
Screwed Bonnet 2 1/2" - 4"  
ASTM B62  
Solder Ends  
KITZ Std.  
3/8" - 4"

# 01



150WOG / 100WSP  
Metal to Metal Seat  
Screwed Bonnet  
ASTM B584, C84400  
Threaded Ends  
KITZ Std.  
1/4" - 4"

# 03

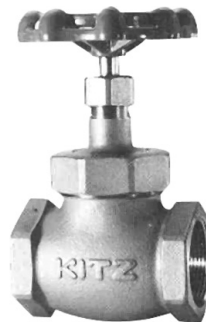

Class 125  
200WOG / 125WSP  
G/F PTFE Disc  
Integral Seat  
Union Bonnet  
ASTM B584, C84400  
Threaded Ends  
KITZ Std.  
1/4" - 3"

## BRONZE GLOBE, ANGLE & CHECK

# 02



Class 150  
300WOG / 150WSP  
Metal to Metal Seat  
Screwed Bonnet  
ASTM B584, C84400  
Threaded Ends  
KITZ Std.  
1/4" - 3"

# 38 (Angle Globe)



Class 150  
300WOG / 150WSP  
Metal to Metal Seat  
Screwed Bonnet  
ASTM B62  
Threaded Ends  
KITZ Std.  
1/4" - 3"

## LIFT CHECK

# 36



250WOG  
Vertical Lift  
Spring Loaded  
FPM Disc  
Screwed Cap  
ASTM B584, C84400  
Threaded Ends  
KITZ Std.  
1/2" - 2"

# 26\*



250WOG  
Vertical Lift  
Spring Loaded  
FPM Disc  
Screwed Cap  
ASTM B584, C84400  
Solder Ends  
KITZ Std.  
1/2" - 2"

\* Product discontinued, available while supplies last

## CAST IRON / GATE

# 72



Class 125  
200WOG / 125WSP  
OS&Y Rising Stem  
ASTM A126, Class B  
Bronze Trim  
Flanged  
MSS SP-70, Type 1  
2" - 14"

# 73

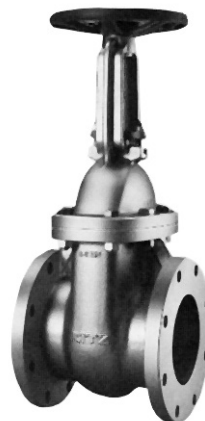

Class 125  
200WOG / 125WSP  
OS&Y Rising Stem  
ASTM A126, Class B  
13Cr. Trim  
Flanged  
MSS SP-70, Type 1  
2" - 14"

# IRON GATE GLOBE & BALL

# 75

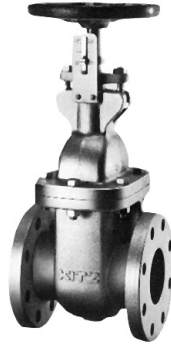

Class 125  
200WOG / 125WSP  
Non-Rising Stem  
ASTM A126, Class B  
Bronze Trim  
Flanged  
Position Indicator  
MSS SP-70, Type 1  
2" - 12"

## GLOBE

# 76



Class 125  
200WOG / 125WSP  
OS&Y Rising Stem  
ASTM A126, Class B  
Bronze Trim  
Flanged  
MSS SP-85, Type 1  
2" - 8"

# 77



Class 125  
200WOG / 125WSP  
OS&Y Rising Stem  
ASTM A126, Class B  
13Cr. Trim  
Flanged  
MSS SP-85, Type 1  
2" - 8"

## BALL

# 90

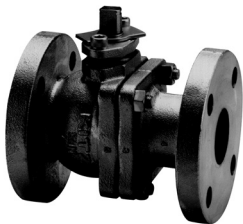

Class 125  
200WOG / 125WSP  
Split Body  
Full Port  
ASTM A126, Class B  
304 SS Vented Ball & Stem  
Flanged  
MSS SP-72  
2" - 8"

# 91

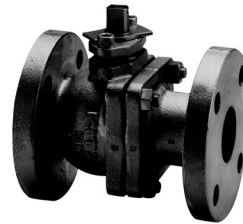

Class 125  
200WOG / 125WSP  
Split Body  
Regular Port  
ASTM A126, Class B  
304 SS Vented Ball & Stem  
Flanged  
MSS SP-72  
6" - 10"



## CHECK

# 78



Class 125  
200WOG / 125WSP  
Swing Type  
ASTM A126, Class B  
Bronze Trim  
Flanged  
MSS SP-71, Type 1  
2" - 10"

# 79



Class 125  
200WOG / 125WSP  
Swing Type  
ASTM A126, Class B  
13Cr. Trim  
Flanged  
MSS SP-71, Type 1  
2" - 10"

## Y-STRAINERS

# 7032

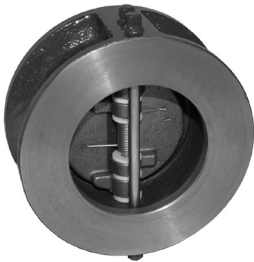

WAFER CHECK  
Class 125  
200WOG / 125WSP  
Double Disc  
ASTM A126, Class B  
316 Disc  
Spring Loaded  
EPDM or Buna seat  
2" - 12"

# 80



Class 125  
200WOG / 125WSP  
Y-Pattern  
ASTM A126, Class B  
304 Screen  
Flanged  
Bolted Cover  
KITZ Std.  
2" - 12"

# 15



300WOG / 150WSP  
Y-Pattern  
ASTM B584, C84400  
304 Screen  
Screwed Cap  
ASTM B584, C84400  
Threaded Ends  
Screwed Cap (Tapped drain)  
KITZ Std.  
¼" - 3"

# 16



300WOG / 150WSP  
Y-Pattern  
ASTM B584, C84400  
304 Screen  
Screwed Cap  
ASTM B584, C84400  
Solder Ends  
Screwed Cap (Tapped drain)  
KITZ Std.  
½" - 2"

# SAMPLE SPEC SHEET

## LEAD-FREE COPPER ALLOY BALL

Two-Piece Body • Full Port • Vented Ball • Blowout Proof Stem • PTFE Seats and Seals  
\*NSF/ANSI 61-G & NSF/ANSI 372

### CODE #868 (AKTAFN) THREADED (1/4"-2")

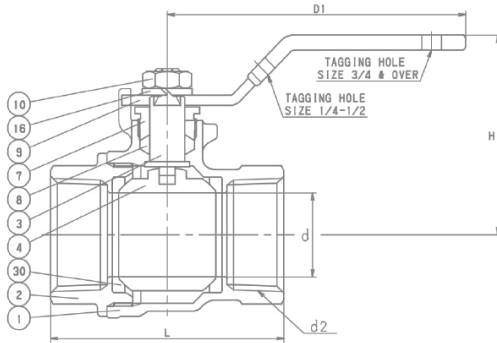

### CODE #869† (CTAFN) SOLDER (3/8"-2")

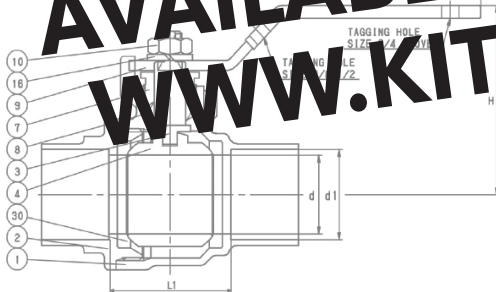

#### STANDARDS

END TO END	KITZ STD.
THREADED ENDS	ASME B1.20.1
SOLDER ENDS	ASME B16.18†
WALL THICKNESS	KITZ STD.
DESIGN	MSS SP-110

#### PRESSURE - TEMPERATURE

600 PSI - NON-SHOCK COLD WORKING PRESSURE (CWP)†  
325 PSI at 212°F NON-SHOCK

#### MATERIAL LIST

NO.	NAME OF PART	SPECIFICATION
1	BODY	LF FORGED BRASS (C46750)
2	BODY CAP	LF FORGED BRASS (C46750)
3	STEM	LF BRASS ROD (C46750)
4	BALL (Vented)	(1) LF FORGED BRASS (C46750) ≤ 3/4" (2) TITANIUM STAINLESS STEEL (316) ≥ 1"
5	GLAND	CARBON STEEL (B16)
6	GLAND PACKING	PTFE
7	HANDLE	(2) CARBON STEEL
8	HANDLE NUT	CARBON STEEL
9	SPRING WASH	CARBON STEEL
10	BALL SEAT	PTFE

**NOTES:**

- (1) SnNi PLATED
- (2) ELECTROPLATED COATING OF ZINC AND PLASTIC COVERING

† P-T LIMITS FOR SOLDER JOINT VALVES PER ASME B16.18

#### DIMENSIONS & WEIGHTS

SIZE	d2	d	H	D1	L	L1	d1		Wt. Lb/Kg	Crtn Qty
							Max	Min		
in	1/4	0.39	1.54	3.23	1.61	-	-	-	0.40	120
mm		9.9	39.1	82.0	40.9	-	-	-	0.2	
in	3/8	0.39	1.54	3.23	1.65	1.05	0.506	0.502	0.40	120
mm		9.9	39.1	82.0	41.9	26.7	12.9	12.8	0.2	
in	1/2	0.59	1.65	3.23	2.09	1.13	0.631	0.627	0.54	96
mm		15.0	41.9	82.0	53.1	28.7	16.0	15.9	0.2	
in	3/4	0.79	2.01	3.94	2.36	1.37	0.881	0.877	0.83	60
mm		20.1	51.1	100.1	59.9	34.8	22.4	22.3	0.4	
in	1	0.98	2.32	5.12	2.83	1.64	1.132	1.128	1.42	36
mm		24.9	58.9	130.0	71.9	41.7	28.8	28.7	0.6	
in	1 1/4	1.26	2.52	5.12	3.23	2	1.382	1.378	2.08	24
mm		32.0	64.0	130.0	82.0	50.8	35.1	35.0	0.9	
in	1 1/2	1.57	2.87	5.91	3.62	2.35	1.633	1.628	3.38	16
mm		39.9	72.9	150.1	91.9	59.7	41.5	41.4	1.5	
in	2	1.97	3.15	5.91	4.13	2.83	2.133	2.128	4.50	16
mm		50.0	80.0	150.1	104.9	71.9	54.2	54.1	2.0	



\*Product complies with NSF/ANSI Standard 61 Annex G, NSF/ANSI Standard 372 and conforms with lead content requirements for "lead free" plumbing as defined by California, Vermont, Maryland, and Louisiana state laws and the U.S. Safe Drinking Water Act that went into effect January 2014.

**KITZ®**

**KITZ®**

SAMPLE SPEC SHEET

# DESIGN STANDARDS

As noted, valves shown on the preceding pages comply with the applicable standards listed below for design, materials, and testing. KITZ valves are manufactured in ISO 9001 Certified production facilities. As the first valve manufacture ISO 9000 certified you can be assured that you are receiving valves of the highest quality and unparalleled service.

## MANUFACTURERS STANDARDIZATION SOCIETY (MSS) of the Valve and Fitting Industry, Inc.

<b>SP-25</b>	Standard Marking System for Valves, Fittings, Flanges and Unions
<b>SP-67</b>	Butterfly Valves
<b>SP-70</b>	Cast Iron Gate Valves - Flanged and Threaded Ends
<b>SP-71</b>	Grey Iron Swing Check Valves, Flanged and Threaded Ends
<b>SP-72</b>	Ball Valves with Flanged or Butt-Weld Ends for General Service
<b>SP-80</b>	Bronze Gate, Globe, Angle and Check Valves
<b>SP-85</b>	Grey Iron Globe & Angle Valves, Flanged and Threaded Ends
<b>SP-110</b>	Ball Valves Threaded, Socket-Welding, Solder Joint, Grooved and Flared Ends

## AMERICAN PETROLEUM INSTITUTE (API)

<b>API 607</b>	Fire Test for Soft Seated Quarter-Turn Valves
<b>API 609</b>	Butterfly Valves: Double Flanged, Lug- and Wafer-Type

## 3rd PARTY CERTIFICATIONS\*

### CSA INTERNATIONAL



**CGA 9.1b-2006/ANSI Z21.15b-2006:** Manually Operated Gas Valves For Appliances, Appliance Conector Valves And Hose End Valves

**CGA requirement CR91-002:** Manually Operated Gas Valves For Use On Piping

**CAN/CGA-3.16-M88:** Lever Operated Non-Lubricated Gas Shut-Off Valves

**ASME B16.33-2002(R2007):** Manually Operated Metallic Gas Valves For Use In Gas Piping Systems Up To 125 psig (1/2" thru 2")

**ASME B16.44-2002(R2007):** Manually Operated Metallic Gas Valves For Use In Aboveground Piping Systems Up To 5 psig.

### UNDERWRITERS LABORATORIES



**ANSI/UL125:** Valves for Anhydrous Ammonia and LP-Gas (other than Safety Relief)  
YSDT - LP-Gas Shutoff Valves, Maximum Working Pressure 250 psig

**UL Subject 258:** Outline of Investigation for Shutoff Valves for Trim and Drain Purposes  
VQGU - Valves, Trim and Drain, 175 psig Max.



**UL 842:** Valves For Flammable Fluids

YRBX - Flammable Liquid Shutoff Valves, Maximum Working Pressure 250 psig

YRPV - Gas Shutoff Valves, Maximum Working Pressure 250 psig

MHKZ - Manual Valves, LP - 250 psig. 150°F, gasoline - 125°F. 250 psig Max.

**UL 1769:** Cylinder Valves

YQNZ - Compressed Gas Shutoff Valves, Maximum Working Pressure 250 psig

### FM APPROVALS



Classification No. 1140 - 175 psig (1205 kPa) rated working pressure

### ANSI / NSF 61 & 372 - Drinking Water System Components



Certified to NSF/ANSI 61 & 372

NSF/ANSI 372

All KITZ LEAD FREE products comply with NSF/ANSI Standard 61 Annex G, NSF/ANSI Standard 372 and conform with lead content requirements for "lead free" plumbing as defined by California, Vermont, Maryland, and Louisiana state laws and the U.S. Safe Drinking Water Act that went into effect January 2014.

# CROSS REFERENCE\*

## BALL

CROSS REFERENCE BRONZE & BRASS

BRONZE & BRASS							
KITZ	APOLLO	CRANE	JENKINS	MILWAUKEE	NIBCO	RED-WHITE	WATTS
51	9A-100/81-100	---	---	---	T560-BR-Y	---	B-6100
54(P)	70-600	---	---	---	T585-70-W3	---	B-6780
58	70-100	9201	201J	BA-100	T580 TFP600	---	FBV-4
58W	70-100-07	---	---	---	---	---	---
59	70-200	9202	202J	BA-150	S580 SFP600	---	FBVS-4
59W	70-200-07	---	---	---	---	---	---
62	82-100	9301	---	30BBOF	T590-Y T595-Y	5050F	B-6800
62M	82-140	9301-S	---	30BSOF	T595-Y-66	---	B-6800-SS
63M	82-240	9302-S	---	30BS1F	S595-Y-66	---	B-6801-SS
68	70-100 80-100	9201	201J	BA-400 BA-425 BA-475	T585-70 T585-70-UL	5044F 5544 5592	B-6080 B-6000-UL
68AB	---	---	---	---	---	---	B-6004
68AD	95-100	---	---	---	---	5060	B-6300
68ALL	---	9201-LL	201J-LL	---	---	---	---
68AMLL	---	9201-S-LL	201SJ-LL	---	---	---	---
68C	78-100	9201-HC	201CJ	BA-100H	T585-70-HC	---	---
68LL	70-100-27	9201-LL	201J-LL	---	---	---	B-6400-LL
68M	70-140 80-140	9201-S	201SJ	BA-400S	T585-70-66	5044S	B-6080-SS
68O	70-800	---	---	---	MTT585-70	---	B-6002
68P	77-100	---	---	20BBOR	TM585-70	---	B-6400
68PM	77-140 71-140 (-64)	---	---	20BSOR	TM585-70-66	---	B-6400-SS-04
68S	75-100-41(-27)	---	---	BA-100ELD	T585-70-SV	5042	B6010
68U	70-300	---	---	---	T585-70-SU	---	B-6001 B-6081
69	70-200	9202	202J	BA-455 BA-485	S585-70	5049F 5549	B-6301
69AD	95-200	---	---	---	---	5063	---
69ALL	---	9202-LL	202J-LL	---	---	---	---
69AMLL	---	9202-S-LL	202SJ-LL	---	---	---	---
69C	78-200	9202-HC	202CJ	---	S585-70-HC	---	---
69M	70-240	9202-S	202SJ	---	S585-70-66	---	B-6081-SS
69U	70-400	---	---	---	S585-70-SU	---	B-6011

IRON							
KITZ	AMERICAN	CRANE	JENKINS	MILWAUKEE	NIBCO	RED-WHITE	WATTS
90	3700	---	---	---	---	---	G4000
---	---	---	---	---	---	---	---
---	---	---	---	---	---	---	---

\* This cross reference chart is provided for the convenience of our customers. Valves listed may not be identical in design, materials of construction or basic pressure rating. KITZ catalogs and those of other valve manufacturers should be consulted for complete details.

# CROSS REFERENCE\*

## BALL

CARBON & STAINLESS STEEL THREADED, SOCKET WELD, BUTT WELD					
KITZ	APOLLO	MILWAUKEE	NIBCO	WATTS	WORCESTER
39	76-100	20SSOR	T580-S6-66-LL	S-8000	---
49M	89-100	20CSOR	T580-CS-66-LL	C-7000	---
50	93-100	---	---	---	5846R
52	---	---	---	---	5866R
53F	---	---	---	---	---
119	92-100-24	---	T560-CS-66-FS-LL	C-7100	---
129	96-100-24	---	T560-S6-66-FS-LL	S-8100	---
217	89-100	20CSOR	T580-CS-66-LL	C-7000	---
219	89-100-24	---	T580-CS-66-FS-LL	C-7000-FS	---
227	76-100	20SSOR	T580-S6-66-LL	S-8000	---
229	76-100-24	---	T580-S6-66-FS-LL	S-8000-FS	---
237	---	22CSOR	---	C-7200	---
239	---	---	---	---	---
247	---	22SSOR	---	S-8200	---
249	---	---	---	---	---
317	83-340	---	TM590-CS-R-66-LL	C-7450	---
317B	---	---	BM590-CS-R-66-LL	---	---
317S	83-440	---	KM590-CS-R-66-LL	---	---
317F	83-540	---	---	C-7480	5946TT
317FB	---	---	---	---	---
317FS	83-640	---	---	---	---
319	83-340-29	35CSOR	TM590-CS-R-66-FS-LL	C-7450-607	---
319B	---	35CS2R	BM590-CS-R-66-FS-LL	---	---
319S	83-440-29	35CS1R	KM590-CS-R-66-FS-LL	---	---
319F	83-540-29	---	---	C-7480-607	AF5946TT
319FB	---	---	---	---	---
319FS	83-640-29	---	---	---	---
327	85-100	---	TM590-S6-R-66-LL	S-8450	---
327B	---	---	BM590-S6-R-66-LL	---	---
327S	85-200	---	KM590-S6-R-66-LL	---	---
327F	86-100	---	---	S-7480	5966TT
327FB	86-700	---	---	---	---
327FS	86-200	---	---	---	---
329	---	35SSOR	TM590-S6-R-66-FS-LL	S-8450-607	---
329B	---	35SS2R	BM590-S6-R-66-FS-LL	---	---
329S	---	35221R	KM590-S6-R-66-FS-LL	---	---
329F	86-500-29	---	---	S-7480-607	AF5966TG
329FB	---	---	---	---	---
329FS	86-600-29	---	---	---	---

\* This comparison chart is provided for the convenience of our customers. Valves listed may not be identical in design, materials of construction or basic pressure rating. KITZ catalogs and those of other valve manufacturers should be consulted for complete details.

# CROSS REFERENCE\*

## BUTTERFLY VALVES

DUCTILE IRON								
STYLE	KITZ	CENTERLINE	CRANE	DEMCO	GRINNELL	JENKINS	MILWAUKEE	NIBCO
W A F E R	5111BG	A2621015	42FXB3G	NF-C-111531A	WD-8102-3	2223BGJ	MW332B	WD1110-5
	5111EG	A2621055	42FXZ3G	NF-C-111535A	WD-8202-3	2223EGJ	MW332E	WD1010-5
	5113BG	A2021015	42FXB3G	NE-C-111531A	WD-8102-3	2223BGJ	MW332B	WD2110-5
	5113BL	A2021013	42FXB3	NE-C-1115311	WD-8101-3	2223BLJ	MW232B	WD2110-3
	5113EG	A2021055	42FXZ3G	NE-C-111535A	WD-8202-3	2223ELJ	MW332E	WD2010-5
	5113EL	A2021053	42FXZ3	NE-C-1115351	WD-8201-3	2223EGJ	MW232E	WD2010-3
	5121BG	A2661055	42BXB3G	NF-C-111431A	WD-8282-3	2222BGJ	MW333B	WD-1100-5
	5121EG	A2661055	42BXZ3G	NF-C-111435A	WD-8282-3	2222EGJ	MW333E	WD-1000-5
	5123BG	A2061055	42BXB3G	NE-C-111431A	WD-8182-3	2222BGJ	MW333B	WD-2100-5
	5123BL	A2061053	42BXB3	NE-C-1114311	WD-8181-3	2222BLJ	MW233B	WD-2100-3
	5123EG	A2061055	42BXZ3G	NE-C-111435A	WD-8282-3	2222EGJ	MW333E	WD-2000-5
	5123EL	A2061053	42BXZ3	NE-C-1114351	WD-8281-3	2222ELJ	MW233E	WD-2000-3
	5133BG	A2044015	42SSB3G	NE-C-112231A	WD-8172-4	2221BGJ	MW334B	WD2128-5
	5133BL	A2044013	42SSB3	NE-C-1122311	WD-8171-4	2221BLJ	MW234B	WD2128-3
	5133EG	A2044055	42SSE3G	NE-C-112235A	WD-8272-4	2221EGJ	MW334E	WD2028-5
	5133EL	A2044053	42SSE3	NE-C-1122351	WD-8271-4	2221ELJ	MW234E	WD2028-3
	5141BG	A2644015	42SSB3G	NF-C-112231A	WD-8172-4	2221BGJ	MW334B	WD1128-5
	5141BL	A2044013	42SSB3	NE-C-1122311	WD-8171-4	2221BLJ	MW234B	WD2128-3
	5141EG	A2644055	42SSZ3G	NF-C-1122351	WD-8272-4	2221EGJ	MW334E	WD1028-5
	5141EL	A2044053	42SSE3	NE-C-1122351	WD-8271-4	2221ELJ	MW234E	WD2028-3
L U G	6111BG	B2621015	44FXB3G	NF-C-511531A	LD-8102-3	223BGJ	ML332B	LD1110-5
	6111EG	B2621055	44FXZ3G	NF-C-511535A	LD-8202-3	2233EGJ	ML332E	LD1010-5
	6113BG	B2021015	44FXB3G	NE-C-511531A	LD-8102-3	2233BGJ	ML332B	LD2110-5
	6113BL	B2021013	44FXB3	NE-C-5115311	LD-8101-3	2233BLJ	ML232B	LD2110-3
	6113EG	B2021055	44FXZ3G	NE-C-511535A	LD-8202-3	2233EGJ	ML332E	LD2010-5
	6113EL	B2021053	44FXZ3	NE-C-5115351	LD-8201-3	2233ELJ	ML232E	LD2010-3
	6121BG	B2661055	44BXB3G	NF-C-511431A	LD-8182-3	2232BGJ	ML333B	LD-1100-5
	6121EG	B2661053	44BXZ3G	NF-C-511435A	LD-8282-3	2232EGJ	ML333E	LD-1000-5
	6123BG	B2061055	44BXB3G	NE-C-511431A	LD-8182-3	2232BGJ	ML333B	LD-2100-5
	6123BL	B2061053	44BXB3	NE-C-5114311	LD-8181-3	2232BLJ	ML233B	LD-2100-3
	6123EG	B2061055	44BXZ3G	NE-C-511435A	LD-8282-3	2232EGJ	ML333E	LD-2000-5
	6123EL	B2061053	44BXZ3	NE-C-5114351	LD-8281-3	2232ELJ	ML233E	LD-2000-3
	6133BG	B2044015	44SSB3G	NE-C-512231A	LD-8172-4	2231BGJ	ML334B	LD2128-5
	6133BL	B2044013	44SSB3	NE-C-5122311	LD-8171-4	2231BLJ	ML234B	LD2128-3
	6133EG	B2044055	44SSZ3G	NE-C-512235A	LD-8272-4	2231EGJ	ML334E	LD2028-5
	6133EL	B2044053	44SSZ3	NE-C-5122351	LD-8271-4	2231ELJ	ML234E	LD2028-3
	6141BG	B2644015	44SSB3G	NF-C-512231A	LD-8172-4	2231BGJ	ML334B	LD1128-5
	6141BL	B2044013	44SSB3	NE-C-5122311	LD-8171-4	2231BLJ	ML234B	LD2128-3
	6141EG	B2644055	44SSZ3G	NF-C-512235A	LD-8272-4	2231EGJ	ML334E	LD1028-5
	6141EL	B2044053	44SSZ3	NE-C-5122351	LD-8271-4	2231ELJ	ML234E	LD2028-3

\* This cross reference chart is provided for the convenience of our customers. Valves listed may not be identical in design, materials of construction or basic.

## CROSS REFERENCE\*

### GATE, GLOBE & CHECK VALVES

BRONZE & BRASS						
KITZ	CRANE	HAMMOND	JENKINS	MILWAUKEE	NIBCO	STOCKHAM
04	---	IB904	996AJ	509	---	B-319
09	7TF	IB413T	106BJ	590T	T-235-Y	B-22T
10	1310	IB423	106BPJ	1590T	S-235-Y	B-24T
11	1	IB440	---	502	T-211-B	B-16
17	362E	IB412	---	572	T-275-B	B-66
17S	382P	IB444	592J	593A	T-276-AP	B-74
18	229C	---	---	---	T-275-Y	B-32
19	76E	IB949	4962J	507	T-473-B	B-375
22	37	IB940	4037J	509	T-413-B	---
22T	41	IB942	4041TJ	509-T	T-413-Y	B-320T
23	1342	IB941	---	1509	S-413-T	---
24	428	IB640	810J	148	T-111	B-100
25	431	IB641	2810J	1150	T-131	B-122
27	438	---	992AJ	---	---	---
28	---	---	993AJ	---	---	---
29	137	IB944	4092J	-	T-433-B	B-321
36	29	---	---	548B	T-480	---
37	634E	IB652	2280UJ	1182	T-174-A	B-144
40	438	IB645	310J	105	T-113	B-103
42T	431UB	IB629	47CUJ	1151	T-134	B-120
45	1334	---	813J	---	---	---
46	437	IB646	2310J	1140	T-133	B-128

IRON						
72	465-1/2	IR1140	454J	F-2885	F-617-O	G-623
73	475-1/2	IR1145	525J	F-2890	F-617-ON	G-613
75	461	IR1138	452J	F-2882	F-619	G-612
76	351	IR116	2342J	F-2981	F-718-B	G-512
78	373	IR1124	587J	F-2974	F-918-B	G-931

\* This cross reference chart is provided for the convenience of our customers. Valves listed may not be identical in design, materials of construction or basic pressure rating. KITZ catalogs and those of other valve manufacturers should be consulted for complete details.







# TERMS & CONDITIONS

## ACCEPTANCE

All quotations are for acceptance within 30 days from date of quotation unless extended in writing. In the event a purchase order is placed after this time, the Seller's company reserves the right to requote prices of all valves offered. All orders and contracts are subject to credit approval and acceptance by KITZ.

## FREIGHT

All materials will be shipped F.O.B. point of shipment - no freight allowance unless otherwise stated and agreed upon with the Buyer.

## PRICES

There will be added to all prices quoted any sales, excise, or similar tax which Seller may be required to collect on or in connection with the sale. Seller reserves the right to cancel any order in the event that selling prices shall be established by Federal, State or other governmental regulation with respect to the products covered by the order which shall be lower than the prices specified in the order.

## ESCALATION TERMS

Prices shown in this price schedule reflect the costs in effect at the time of publication. These prices will remain firm on all products with a quoted delivery of twenty six (26) weeks or less. On products with a quoted delivery of more than 26 weeks, the Seller has a right to price and invoice at the applicable price sheet in effect at the time of shipment. In no event will the invoiced price be less than price originally quoted.

## DEFERRED SHIPMENTS

If for any reason the Buyer desires to delay shipments more than 30 days after manufacturing or to place a hold or to stop the order during the manufacturing cycle, the Seller's company reserves the right to consider the order cancelled and to invoke cancellation charges.

## CREDIT TERMS

As quoted. Overdue balances will be subject to 1.5% service charge per month on such indebtedness.

## DELIVERIES

Shipments made to the Buyer shall at all times be subject to the approval of Seller's Credit Department. All schedules of shipments are estimated as closely as possible and Seller will use its best effort to ship within the time schedule but does not guarantee to do so. Seller shall not be liable for any direct, indirect, or consequential damage or loss caused by delay in delivery, regardless of the cause of delay. Items offered from stock are subject to prior sale.

## RETURNS

No returns are allowed without prior arrangements made with the Seller. Product considered for return must be in new, resalable condition and of current design.

## WARRANTY

Seller will replace without charge or refund the purchase price of products manufactured by Seller which prove to be defective in material or workmanship, provided in each case that the product is properly installed and is used in the service for which Seller recommends it and that written claim, specifying the alleged defect, is presented to the Seller within one year from the date of shipment. For Copper Alloy and Iron valves sold and installed in the U.S. the warranty\* is five years. Seller shall in no event be responsible for claims of A) labor, expenses, or other damages occasioned by defective parts or products or for B) consequential or secondary damages. **The Warranty stated in this paragraph is in lieu of all other warranties, either expressed or implied. With respect to warranties, this paragraph states Buyer's exclusive remedy and Seller's exclusive liability.**

## DESIGN

Because of a policy of continuous product improvement, Seller reserves the right to change design, materials or specifications without notice. There will be a charge for modifying an order after it has been entered when such change or modification results in additional engineering or clerical work for either KITZ or its suppliers.

## NOTE

KITZ reserves the right to correct any obvious clerical errors in quotations, invoices and other contracts.

\*K-Press warranty is limited to two years.





KITZ Corporation of America, Stafford, Texas



**KITZ**®  
PRODUCT OF TECHNOLOGY

**KITZ Corporation of America, Inc.**  
10750 Corporate Drive Stafford, TX 77477  
800-772-0073 | T 281-491-7333 | F 281-491-9405  
[www.kitzus-kca.com](http://www.kitzus-kca.com)